

# Porto typ 10

1/2

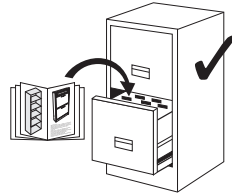

GB Assembly instruction  
D Montageanleitung  
PL Instrukcja montażu

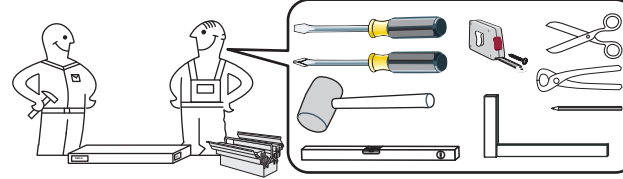

**ACHTUNG! / CAUTION! / UWAGA!**

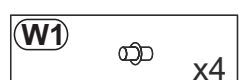
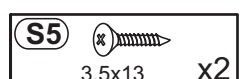
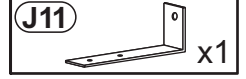
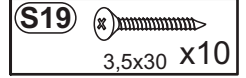
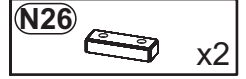
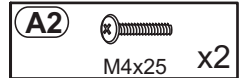
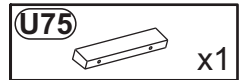
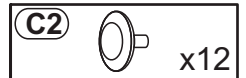
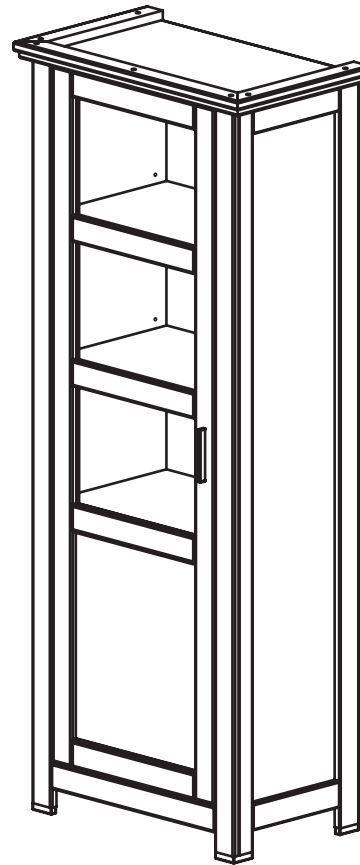
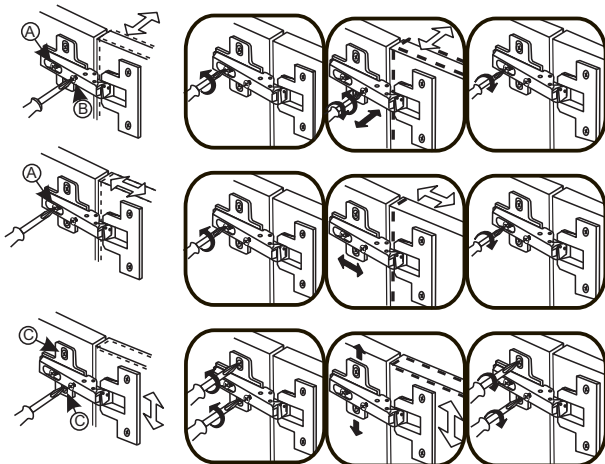
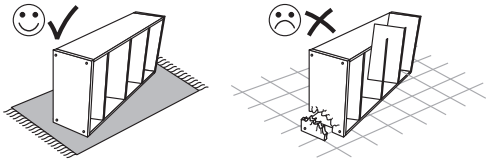

# Porto typ 10

2/2

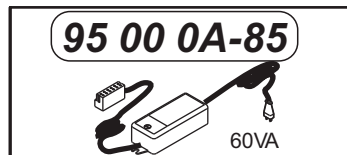
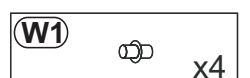
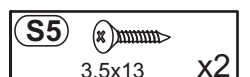
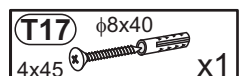
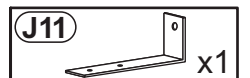
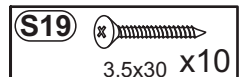
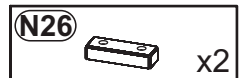
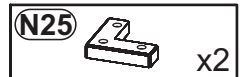
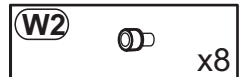
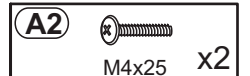
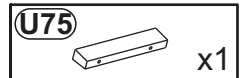
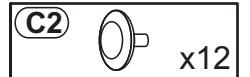
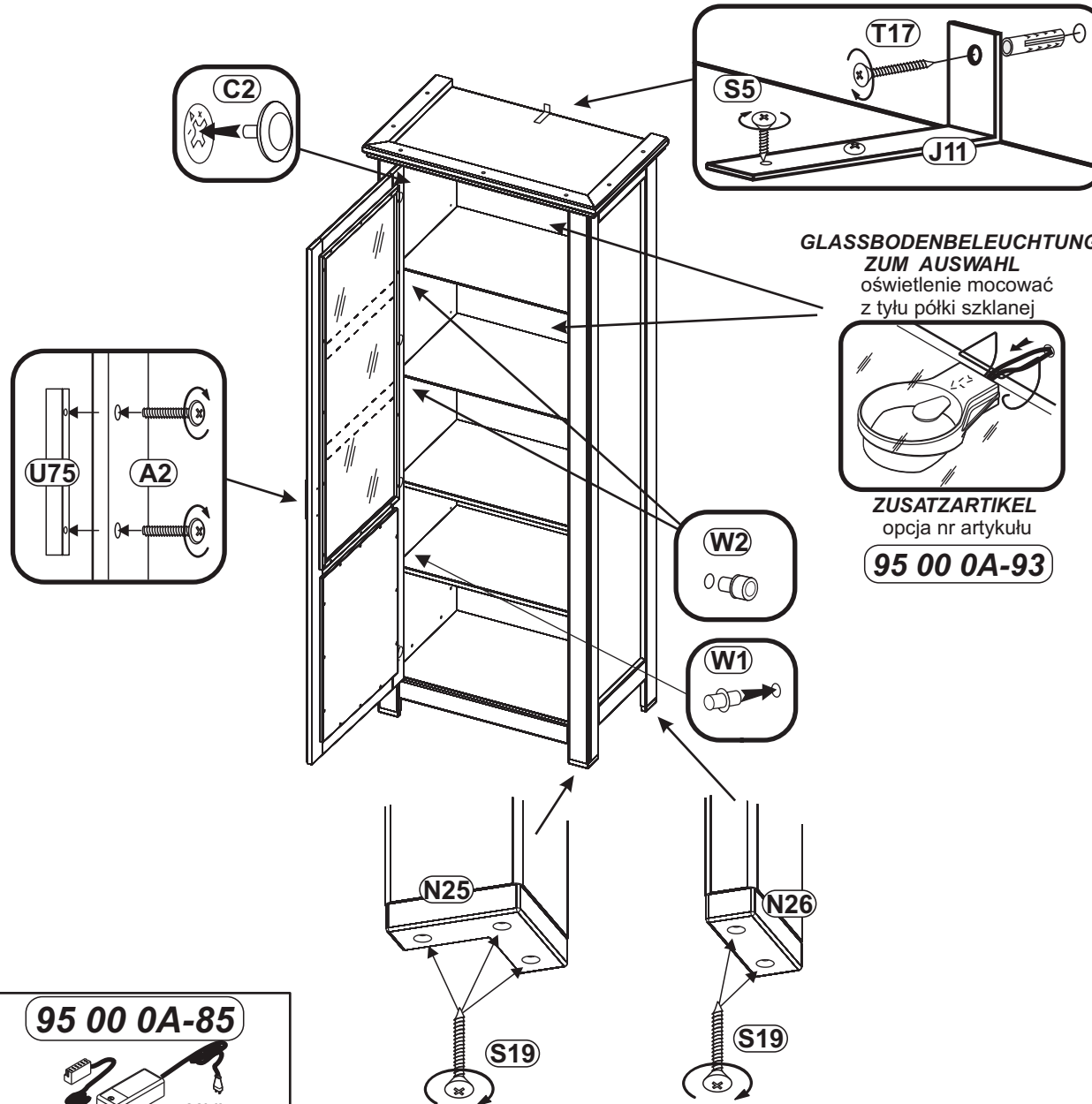

# Porto typ 10

1/1



**GB** Service card  
**D** Servicekarte  
**PL** Karta serwisowa

**D** Sehr geehrter Kunde. Wir gratulieren Ihnen zum Erwerb Ihres neuen Möbelstücks. Da wir auf die Zufriedenheit unserer Kunden viel Wert legen, bitten wir Sie, bevor Sie mit der Montage beginnen, den Beschlagbeutel sorgfältig zu überprüfen. Sollte ein Teil fehlen oder beschädigt sein, kreuzen Sie dieses deutlich auf der Montageanleitung an und schicken uns diese zu

**GB** Dear Customer. We would like to congratulate you buying a new furniture. Because we emphasize our customer satisfaction, please check very carefully the bag with fittings before you start assembling. If some parts are missing or are broken please mark it with "X" sign on assembly instruction and send it to us.

**PL** Szanowny Kliencie. Gratulujemy zakupu nowego mebla. Ponieważ kładziemy duży nacisk na zadowolenie naszego Klienta, prosimy dokładnie sprawdzić torbę z okuciami zanim zaczniecie montować. Gdyby brakowało jakiejś części lub byłaby uszkodzona proszę to oznaczyć krzyżykiem na instrukcji montażowej i przesłać instrukcję.

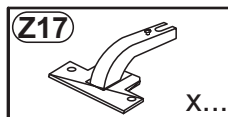
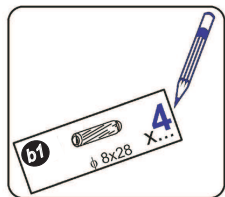
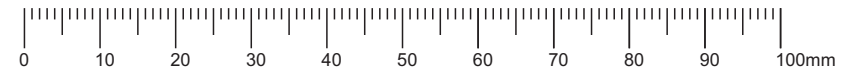
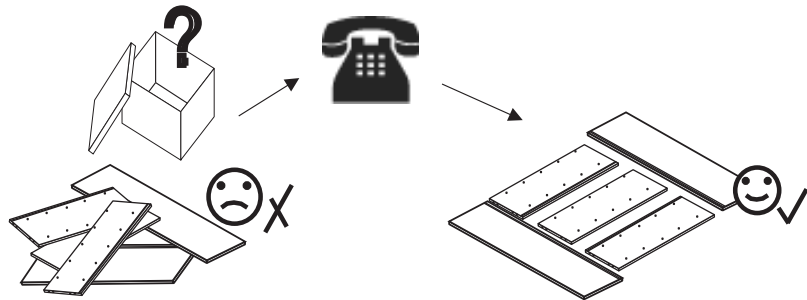
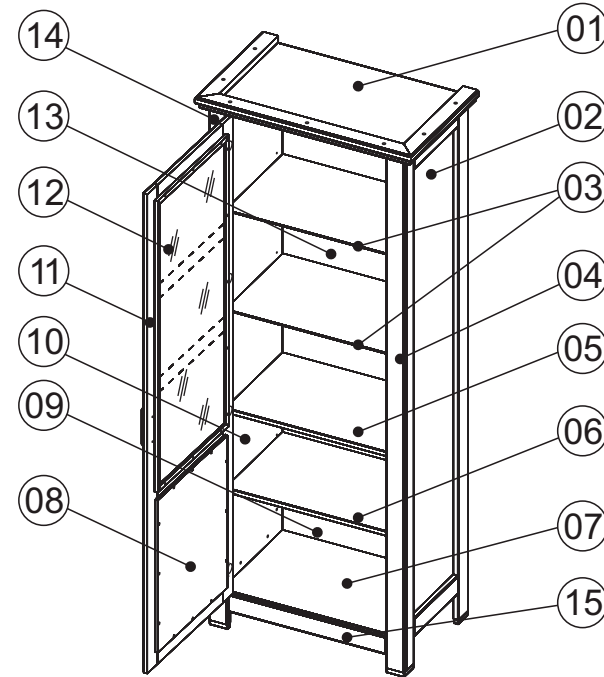

<b>S12</b> 4x30 X...	<b>F6</b> X...	<b>B1</b> $\phi$ 8x28 X...	<b>S5</b> 3,5x13 X...	<b>P2</b> 3x16 X...	<b>N25</b> X...	<b>U75</b> X...
<b>T17</b> $\phi$ 8x40 4x45 X...	<b>W1</b> X...	<b>T1</b> X...	<b>D3</b> H4 X...	<b>K5</b> 7x50 X...	<b>N26</b> X...	<b>A2</b> M4x25 X...
<b>C2</b> X...	<b>W2</b> X...	<b>M1</b> X...	<b>E1</b> X...	<b>J11</b> X...	<b>S19</b> 3,5x30 X...	<b>P15</b> 3x20 X...